



SVOË MESTO

Kayfun X

User manual

1. Before use

The SvoëMesto Kayfun X is a rebuildable tank atomizer specifically designed to vaporize e-liquid for electronic cigarettes. Before use you must install a coil intended for use in electronic cigarettes. It is recommended to clean the device with water, dry and lube all visible o-rings with e-liquid.

ATTENTION: Do not use oils or oil-based fluids with the atomizer.

This manual is meant as a brief overview on the general functionality of the SvoëMesto Kayfun X. If you have no experience using a rebuildable atomizer or creating coils, please consult your local vendor.

Further information and languages at www.svoemesto.de.

2. Application

The SvoëMesto Kayfun X recommended use is for coils with a minimum resistance of 0.5 ohm and an electric input from 5 to 25 watts. Please use the atomizer responsibly and the coils you've created at your own risk.

2.1 Accessing the deck

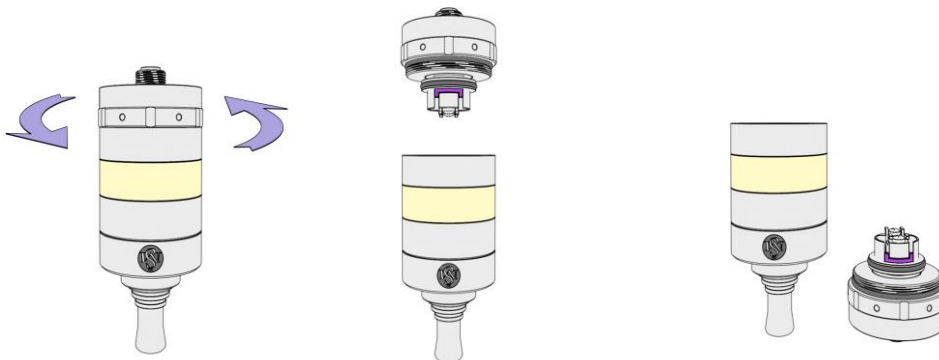

Step 1
Flip the atomizer upside down, if the tank is filled.

Step 2
Unscrew the base counter-clockwise.

Step 3
Remove the base to access the deck.

2.2 Installing coil and wick

The coil is placed diagonally between the build screws and approx. 1.5 mm – 2 mm above the air outlet, so that air can smoothly flow around the coil. The ends of the wire are placed under the build screws and then clamped underneath them.

The overhanging ends of the wick should be placed in the empty spaces beneath the terminals, so that they lay above the liquid channels. Before assembling the atomizer, it is recommended to saturate the wick with e-liquid.

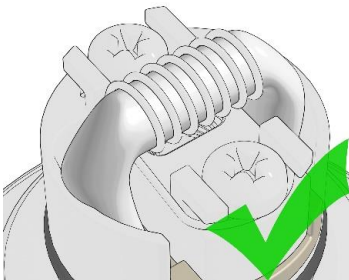
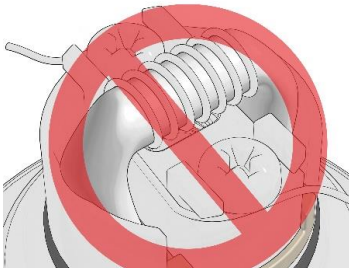

ATTENTION: For your own safety please note the following

- The coil has to be connected with one end at the plus terminal, with the other end at the minus terminal.
- The exceeding ends of the wire have to be cut flush with the terminals and must not stick out of the build deck. Otherwise, this may cause a short circuit.
- The coil must not touch the deck itself.

2.3 Setting airflow

The Kayfun X has the continuously adjustable airflow control system AEROKON.

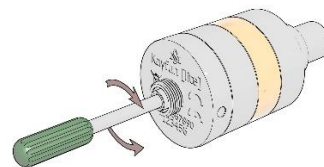
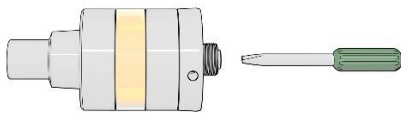

Step 1

Insert a small flathead screwdriver into the 510 connector in the bottom. While fully assembled, put the Kayfun X with the mouthpiece to your lips and draw on it.

Step 2

Turn the screw inside the 510 connector clockwise to tighten the airflow or counter-clockwise to loosen it.

2.4 Filling

For filling the Kayfun X has to be assembled completely

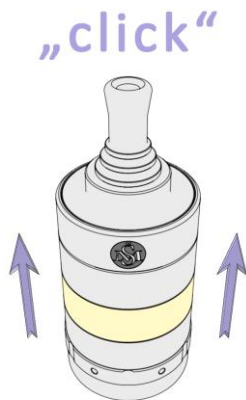

Step 1

Lift the tank up until you feel a “click”. The liquid channels are now closed.

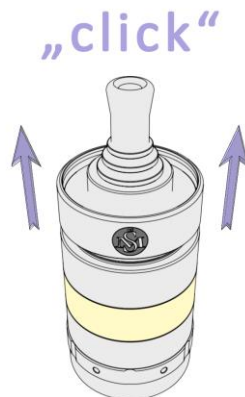

Step 2

Lift the topcap up until it snaps into place.



Step 3

Push against the engraving to open the fill port and Fill the tank through the fill port, then reverse steps 2 and 1.

3. Warranty

The manufacturer's warranty is one year on all stainless-steel parts. Excluded from warranty are all plastic components such as tanks and insulators, glass tanks and o-rings.

4. Disclaimer

With the SvoëMesto Kayfun X, please use original SvoëMesto accessories only. The manufacturer accepts no liability for any third-party accessories or issues which may have been caused or exacerbated by their use.

5. Warnings

- Before use, please read the manual carefully!
- Please keep the atomizer dry!
- Do not use the atomizer for other purposes than intended!
- Connect the atomizer to a power source that is suitable for its intended use!
- Using the atomizer on high voltages or without a fluid can damage the atomizer. The manufacturer accepts no liability for atomizers that were damaged during use.
- Using the atomizer incorrectly not only can lead to a defect of the atomizer, but also cause fire.
- Keep the atomizer away from heat sources.
- Not suitable for children. Please keep the atomizer away from children!

